

# RS Adria II

## Operating Manual

■ RS Adria II

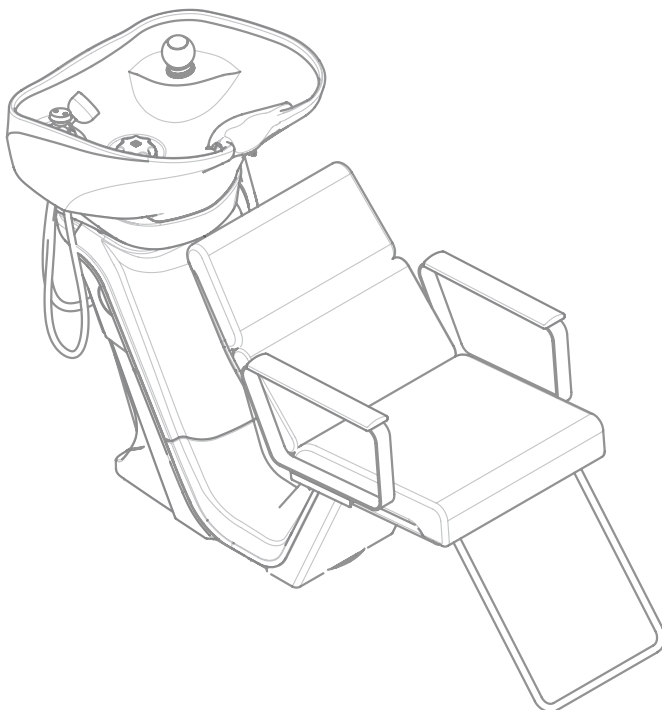

### Table of Contents

Description of Warning Symbols	2
Safety Precautions	2
Precautions for Use	5
Precautions for Handling Synthetic Leather	8
Position of Warning Labels	8
Precautions for Basin	8
Before Using This Product	9
Precautions for Resin (Plated) Parts	9
Name of Parts	9
Accessories	10
Preparations	10
How to Use	11
Maintenance	16
Daily Inspections	22
Parts Replaced on a Regular Basis	22
Standard Duration of Use	22
Before Requesting Repairs	23
Consumable Supplies	23
Disposing of This Product	24
After-sales Service	24
Specifications	25
Dimensions	26
Procedures for Daily Inspections	27

Thank you for purchasing this Takara Belmont product.

**The instructions contained in this booklet should be thoroughly read and understood before use.**

Using this product before reading this operating manual may result in an accident.

This product is an industrial shampoo unit designed for barbers and hair salons.

Only use this product for its intended purpose and do not use it for non-hairdressing work.

Keep this manual and refer back to them when required.

This product is designed for shampooing and hair/scalp care.

Version 1

April 2016

# Description of Warning Symbols







## ■ Before using this product

The "Safety Precautions", "Precautions for Use" and "Precautions for Handling Synthetic Leather" contained in this booklet should be thoroughly read and understood before use.



## ■ Precautions listed here

The precautions listed here are to ensure that this product can be used safely, and to prevent any danger or risk to the person using this product or those around them. These precautions are important for ensuring safety. Adhere to these precautions at all times. Takara Belmont is not responsible for any damage or risk to the person using this product or those around them due to accidents if this product is used without adhering to the "Safety Precautions", "Precautions for Use" and "Precautions for Handling Synthetic Leather". In this case, the person failing to adhere to the "Safety Precautions", "Precautions for Use" and "Precautions for Handling Synthetic Leather" will be responsible for any damage or risk incurred. Detailed descriptions of symbols are provided below. Read and understand these symbols thoroughly before reading this manual.

## ■ Symbols

 <b>Warning</b>	If this symbol is ignored and the product is used, "there is the risk of death or serious injury to the user".
 <b>Caution</b>	If this symbol is ignored and the product is used, "there is the risk of light or moderate injury or physical damage".
<b>Note</b>	Description of "ideal points to adhere to for safety".
 Common danger, warning and caution notifications  Guidance or instruction regarding common user actions  Common prohibited actions	 Notification of high temperature warning CAUTION Hot water  Prohibited disassembly or repairs/modifications Disassembly Prohibited

# Safety Precautions (Adhere to these precautions at all times)

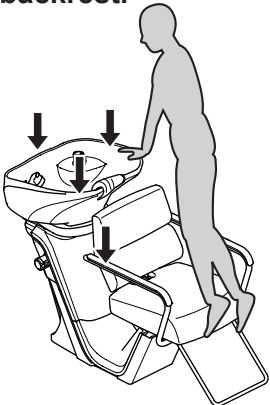
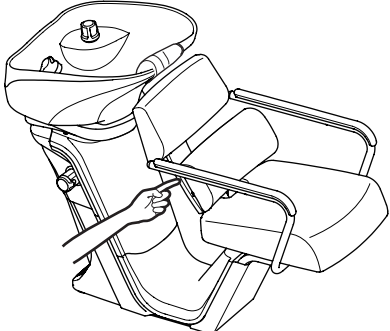
 <b>Warning</b>	
 <b>Do not climb on parts such as the basin, armrest or backrest.</b> Do not climb on, pull or apply excessive force to parts such as the basin, armrest, backrest or footrest. Failure to follow this instruction may damage the product or cause it to fall over.	 <b>Do not insert fingers into movable parts.</b> Do not insert fingers into movable parts. Failure to follow this instruction may cause injury.
	



## Warning



### Adhere to the following when operating the seat.

When operating the seat, check and make sure that there are no people or objects around the seat. The seat may hit them when operating, leading to injury.

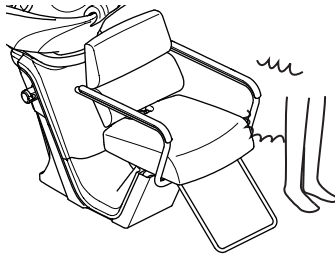

CAUTION  
Hot water

### Do not use hot water (boiling water) of 60°C or higher.

Using hot water of 60°C or higher may deform or damage the parts such as the basin, shower head and water stop knob.



Disassembly  
Prohibited

### Disassembly and repairs/modifications are prohibited.

Disassembly, repairs and modifications must not be conducted by people other than qualified repair technicians. Failure to follow this instruction may cause electrocution, fire or abnormal operation, leading to injury.

< Basin Tilt Specification >

To adjust the degree of tilt of the basin, see the section "Adjusting Basin Movement" (p.16).

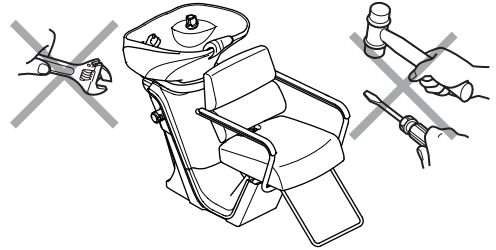

### Adjust the water temperature while checking the temperature by hand.

When adjusting the temperature of the water, reduce the volume of water, point the shower head away from the customer and check the temperature by hand. Take care when doing so, as hot water may come out of the shower head.



### Return the temperature control knob to an appropriate position after using hot water.

- Return the temperature control knob to an appropriate position after using hot water. Continuing to use the hot water with the knob in the hot position may cause burns.
- Using other equipment that share the same water/hot water supply source at the same time may cause unstable water temperature. If multiple equipment are to be used, move the temperature control knob slowly to adjust the water temperature.



### Do not lean on the basin

Leaning on the basin may cause the basin to fall over.

Also, coloring dyes on the neck cushion or basin may stain the user's clothes.







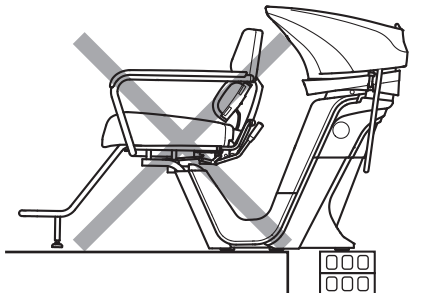









### Install on a stable area

Install the main body on a flat, firm floor, and fix it securely. Failure to follow this instruction may cause the main body to fall over.

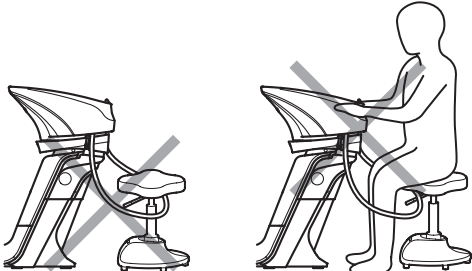

## ⚠ Caution

<p> <b>Do not hit the unit with objects.</b> Do not hit the unit with hard objects. Failure to follow this instruction may cause deformation or damage to the unit.</p>	<p> <b>Do not touch the hot water supply pipe or mixing pipe.</b> The hot water supply pipe or mixing pipe may become very hot. Do not touch the pipes directly.</p>
<p> <b>Support the customer's head by hand when lowering or lifting the backrest.</b> Support the customer's head by hand when lowering or lifting the backrest. Failure to follow this instruction may cause injury.</p>	<p> <b>Do not use outdoors.</b> This product is designed for indoor use. Do not install this product outdoors or within a vehicle. Be sure to only use this product inside a barber or hair salon. Failure to follow this instruction may cause malfunctions or damage to the main body.</p>
<p> <b>Do not drink the hot water.</b> This product is designed for washing hair. Do not drink the hot water. The water quality may cause diarrhea or stomach pain.</p>	<p> <b>Only use this product for its intended purpose and do not use it for non-hairdressing work.</b> This product is an industrial product designed for barbers and hair salons. Only use this product for its intended purpose and do not use it for non-hairdressing work.</p>
<p> <b>Do not use this product if the coating is peeling.</b> Replace the water taps (water stop knob, temperature control knob) or step if the coating is peeling. Continuing to use this product when the coating is peeling may cause injury.</p>	<p> <b>Do not use the product in a place where freezing is expected.</b> Failure to take this precaution may result in breakage of parts, thus resulting in water leaks. Repair of breakage due to freezing will result in fees being charged even during the warranty period. If freezing is expected, maintain the room temperature at 0°C or above by using a heater.</p>
<p> <b>Pay attention when cleaning the basin.</b> Failure to take this precaution may result in injuries by the sink outlet fixture in the basin.</p>	<p> <b>Do not use this product with the cover broken.</b> Replace the cover if it breaks. Continuing to use this product with a broken cover may cause a malfunction or an accident.</p>
<p> <b>Do not spray areas other than the basin with water.</b></p> <ul style="list-style-type: none"> <li>● Take care not to spray areas other than the basin with water. If water does come in contact with areas other than the basin, wipe them dry as soon as possible. Water entering the main body may cause malfunctions or a ground leakage fire.</li> <li>● Take care not to allow water to drip on the floor. If water does drip on the floor, wipe it dry as soon as possible. Failure to follow this instruction may damage the floor, or cause water leakage.</li> </ul>	<p> <b>Take care when handling the shower hose.</b></p> <ul style="list-style-type: none"> <li>● When using the basin, check that the shower hose is not trapped around feet or under the stool. Failure to follow this instruction may cause damage to the basin.</li> <li>● Do not step over the shower hose to use it. Failure to follow this instruction may cause the shower hose to become caught on the basin, leading to injury.</li> </ul>
<p> <b>Do not turn the water fully on with the shower head in the shower head bracket.</b> Failure to follow this instruction may cause water to spill out of the basin, covering the customer with water. When turning the water on with the shower head in the shower head bracket, check the surrounding area and turn the water stop knob slowly.</p>	<div style="text-align: center;">  </div>
<p> <b>Do not subject the unit to shocks.</b> Do not subject the unit to shocks. Failure to follow this instruction may cause damage, leading to injury.</p>	

# Precautions for Use

## ⚠ Caution



### Set the water temperature for this product to 80°C or less.

Failure to follow this instruction may cause malfunctions or damage in parts such as the stop valve, check valve, flexible pipe and thermostat water valve.



### Always wipe the floor clean if it is wet.

Wipe the floor as soon as possible if it is wet after shampooing. Failure to follow this instruction may damage the floor or cause degradation and malfunctions to parts in contact with the floor or the foot switch. Wet floor may cause falling or water leakage to downstairs leading to an accident.



### Do not use strongly acidic or strongly alkaline cleaning solvents.

Do not use cleaning solvents containing mainly caustic soda (NaOH) or caustic potash (KOH) to clean the drain pipe. Never pour thinners, alcohol, nail polish remover, gasoline or kerosene into the drain. Failure to follow this instruction may cause damage to the drain hose.



### In cold regions, ensure that water is removed.

When using this product in winter in cold regions, open the maintenance cover and open the check valve filter to remove water and prevent freezing. Failure to follow this instruction may cause water leakage.



### Always use the neck cushion.

Using this product without the neck cushion may apply unnecessary load to the customer's neck, causing injury. Always use the neck cushion.



### Pay attention to the handling of the neck cushion.

Do not touch or scratch the neck cushion with a cutting tool, such as scissors, or an edged tool (including long nails). Failure to take this precaution may result in scratches or damage to the surface.



### Do not use an abrasive compound.

Do not use an abrasive compound to clean the water faucet fixtures (showerhead, showerhead receptacle, water stop knob, and temperature control knob). Use of an abrasive compound, sponge with abrasive compound, or hard cleaning tools, such as wire wool or a nylon scrubbing brush, may damage the fixture surface.



### Do not use peppermint or aroma oil.

Do not use peppermint or aroma oil containing menthol. Failure to take this precaution may damage the resin parts, such as the showerhead, showerhead receptacle, shower hose, water stop knob, temperature control knob, neck cushion, hair catcher, and drain cap.



### If chemicals spill on to this product, wipe them dry as soon as possible.

If chemicals such as hair dyes spill on to this product, wipe them dry as soon as possible. Failure to follow this instruction may cause discoloration, deterioration or deformation. Also, if chemicals spill on to the floor, wipe them dry as soon as possible.

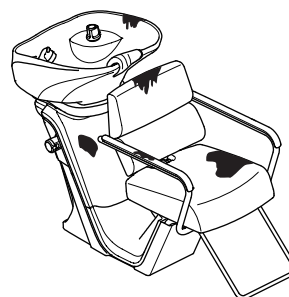

### Do not cover the drain outlet when this product is not going to be used.

Do not cover the drain outlet with the drain cap, towel, or shampoo cloth after finishing the work. Water may overflow the basin when water is improperly discharged or a small amount of hot water is discharged due to an increase in water pressure during the night, resulting in water leaks.

Be sure to remove the trap cover from the drain outlet when the product is not in use.

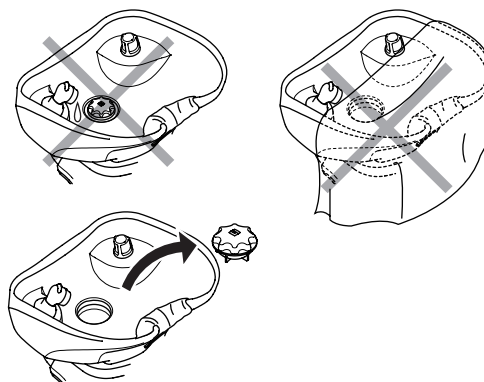

## ⚠ Caution



### Do not wet the shower head bracket with water.

Do not wet the shower head bracket with water. Failure to follow this instruction may cause water leaks.

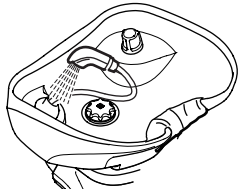

### Do not strike the resin (plated) parts with a hard object.

Do not strike the resin (plated) parts, such as the water stop knob and temperature control knob (upper part), with a hard object. Failure to take this precaution may cause flaws or cracks on the plated surface and peeling of plating, thereby resulting in injuries.



### Do not wipe with chemicals or apply heat.

Failure to follow this instruction may cause deformation or discoloration. If chemicals spill on to the leather or covers, wipe them dry as soon as possible.

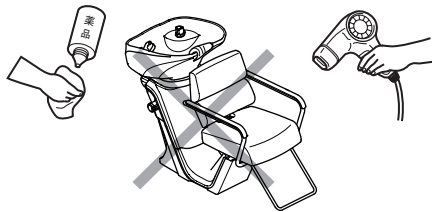

### Close the water stop knob firmly.

After use or shampooing is complete, turn the water stop knob firmly in a clockwise direction and turn the water off completely. Failure to turn the water off completely may cause water leakage.



### After use, wipe water away from all parts other than the basin.

Leaving the main body with water on it may cause damage, and make dirt difficult to remove.



### Do not move the basin swiftly.

Move the basin gently, paying attention to avoid hitting people or objects.



### Avoid direct sunlight or heat from a stove.

Avoid direct sunlight or heat from a stove. Failure to follow this instruction may cause discoloration or degradation of the leather.

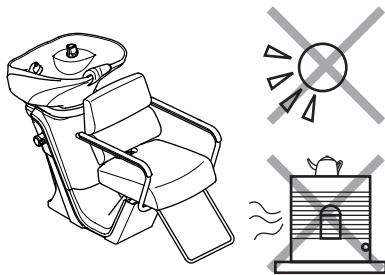

### Do not practice front shampooing.

This product is intended for side shampooing and backward shampooing. Practicing the front shampooing may cause water leaks, thus wetting the floor.



### Return the shower head to the shower head bracket so that the spray nozzle faces the basin.

Failure to follow this instruction may cause water to spill out of the basin or splash on the customer with water.

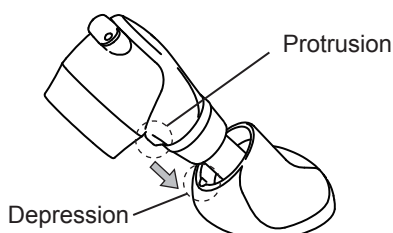

### Do not hit the cover with objects, or kick the cover.

Failure to follow this instruction may cause malfunctions or accidents, leading to damage to the main body.

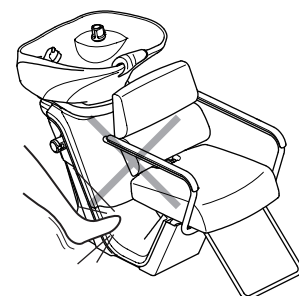

**⚠ Caution**



**Do not leave the shower head immersed in water.**

If pressure in the water pipes decreases due to repairs that follow water stoppages, the water in the basin may flow back through the shower head.



**Do not drop heavy objects on to the basin.**

Do not place or drop heavy objects on to the basin. Failure to follow this instruction may cause damage such as scratches or cracks to the basin.



**Clean the hair catcher regularly.**

Clean the hair catcher as regularly as possible. Continuing to use the hair catcher without cleaning it may cause the drain to become blocked with hair, leading to water overflowing and unhygienic conditions. Try to clean the hair catcher after each shampoo.



**Do not move the basin with water filled.**

Be sure to check that there is no water in the basin before moving it. Failure to take this precaution may cause the water to spill out of the basin and splash onto the customer.

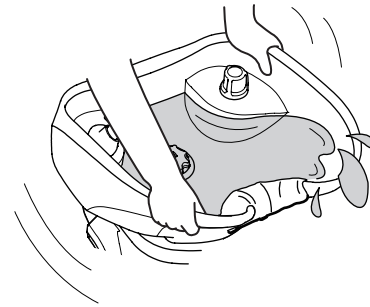

**Pay attention to maintenance methods.**

Be sure to execute daily maintenance according to the section "Maintenance" on page 20. In the case of insufficient or improper maintenance or when periodically replaced parts are not replaced, the customer shall be responsible for any harm, damage, or defects that result; our company shall not assume responsibility.

# Precautions for Handling Synthetic Leather

## ⚠ Handling precautions

### ● Stains caused by clothing dyes

The synthetic leather of this product may become stained by direct contact with clothes or belts. If there is stains, wipe clean as quickly as possible with a 10% detergent solution diluted using water to prevent permanent staining.

### ● Take care of deformation or stains due to direct contact

- Direct contact with other objects such as plastic products, painted items, solvents or adhesive tape may cause changes to the surface luster, cracking, deformation or peeling.
- Direct contact with newspaper or printed paper may cause stains.
- Direct contact with items of clothing such as printed images of t-shirts, or jeans may cause discoloration of the synthetic leather of this product.
- Direct contact with solvents such as benzene, nail polish remover, alcohol, oil (including beauty treatment oils) may cause discoloration, melting of the surface, elution of the plasticizing agent, changes to surface luster, hardening/softening or peeling.
- Using bleach or bleached sheets may cause changes to surface luster or discoloration.
- Installing this product next to sources of excess heat such as irons or heaters may cause deformation or discoloration.
- Protect this product from direct sunlight by installing curtains. Failure to follow this instruction may cause changes, shrinking, discoloration or fading of the leather surface.
- Placing heavy objects for a long period of time may leave an imprint or wrinkles on the synthetic leather that cannot be removed.

## Position of Warning Labels

⚠ CAUTION	⚠ CAUTION	⚠ CAUTION
⊘	!	⊘
Do not use hot water of 60°C and higher. Using hot water at 60°C and higher may deform or damage the ceramic bowl, the shower head or the faucet handle.	If chemical such as hair dye attached to the equipment, wipe it out immediately, or it may cause discoloration or deterioration.	Do not use chemical detergent mainly containing caustic soda (NaOH) & caustic potash (KOH) for cleaning drain pipes, etc. This may cause damage on the drain hose, etc.
For other cautions, please read the operating instruction carefully before use.		

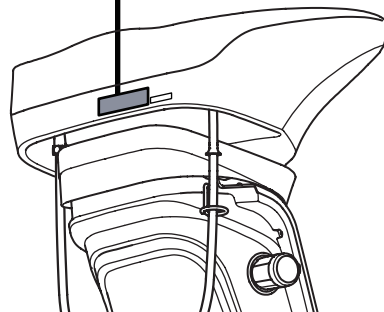

## Precaution on Basin

This product employs a ceramic basin. Since bending or deformation cannot be avoided when forming the basin, the position, height, or shape of the neck differs slightly from product to product.



# Before Using This Product

- The back wash basin is a shampooing product designed for performing back shampooing\*<sup>1</sup> or hair/scalp care.
- Check that all accessories have been attached properly.
- Please note that the gap between the backrest and the basin when the backrest is reclined may vary slightly from product to product.

\*1 Back shampooing: the user stands behind the basin and performs shampooing from the back (back position).

# Precautions on Resin (Plated) Parts

- Resin plating is adopted for part of the water stop knob and the temperature control knob.
  - Plating is a thin, hard metal film applied to the surface that may crack or peel due to corrosion or aged deterioration.
  - Flaws or cracks may occur on the plated surface due to impacts from falling objects.
  - Flaws or cracks may occur on the plated surface when a hard object hits the surface.
  - Peeling of the plating may occur from flaws or cracks on the plated surface.

## ⚠ Caution

Check to ensure that there are no flaws, cracks, or peeling of the plated surface of the knobs before using the product. If peeling is observed, immediately stop using the product and contact your closest dealer or Takara Belmont. Continued operation may result in injuries.

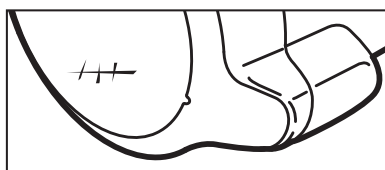

Example of Flaws on the Plated Surface

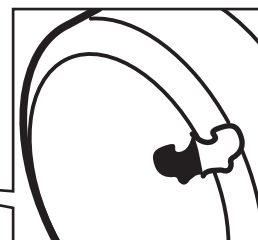
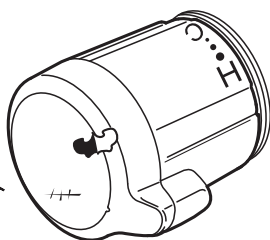

Example of Peeling of the Plated Surface

# Name of Parts

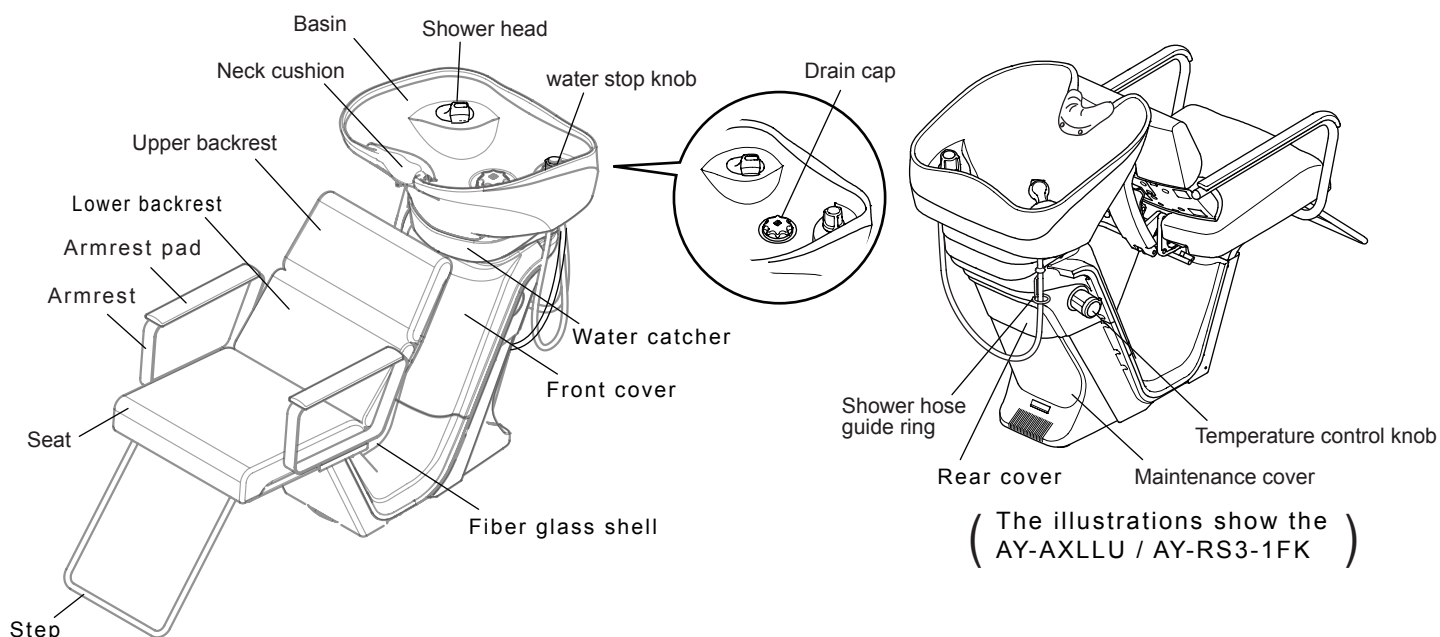

# Accessories

□ Neck cushion...1



□ Drain cap...1



□ Hair catcher...1



□ Trickle stopper rubber...1

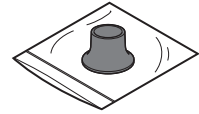

□ Wrench...1



□ Hexagonal-head wrench...1



□ Installation instructions...1

□ Operating Manual...1

□ Setting sheet...1

□ Showerhead Cleaning Instruction Manual...1

□ Operation Instruction Manual for Trickle Stopper Rubber ...1

# Preparations

## ■ Attach neck cushion on the basin

- 1 As shown in the illustrations, check the proper direction of the neck cushion and fit it to the basin along the basin edge.



### Caution

Check the front and back. When the cushion is mounted in the wrong direction, it may contact the backrest.

- 2 Secure the hooks of the neck cushion to the fixing pins on the inner side of the basin.



The fixing pins are detachable. Be careful not to lose them.

- 3 While shaping the neck cushion along the basin edge, secure the hooks of the neck cushion to the fixing pins on the outer side of the basin.

## ■ Remove neck cushion

- 1 Hold the hooks when removing the neck cushion.



### Caution

Applying excessive force to remove the neck cushion may damage the parts.

### Note

The neck cushion is consumable supply. Replace it if it is extremely dirty or the surface has deteriorated. (available at additional cost)

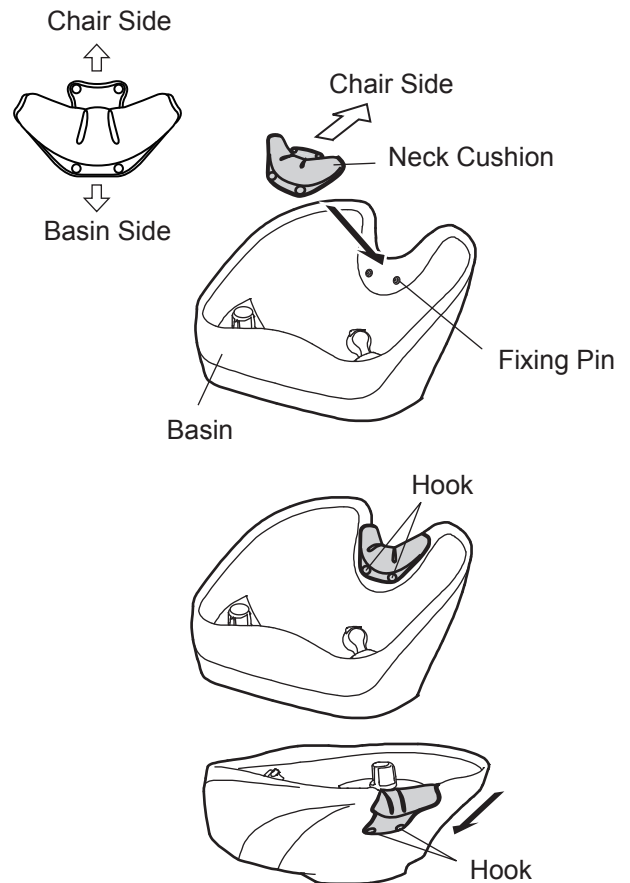

# How to use

## RS Adria II

- 1 Allow the customer to be seated in the chair and then apply the shampoo cloth. The customer may place the feet on the step as required.

**Caution** When seated, inform the customer not to place any weight on the backrest in advance. Failure to take this precaution may result in the customer's body hitting the basin.

- 2 Move the basin position according to the neck position of the customer.

**Caution** To move the basin, be sure to hold it at the leading and the trailing end of the basin as illustrated. Failure to take this precaution may result in operational failure.

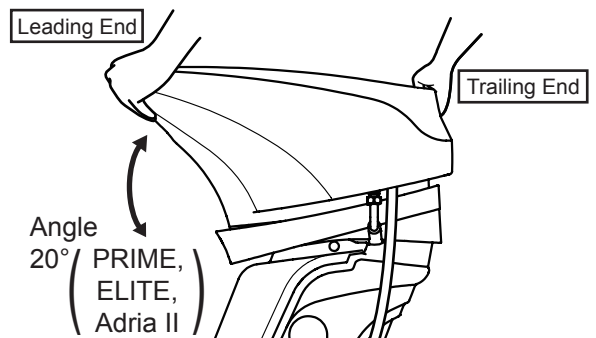

- 3 Allow the customer to grip the armrest of the chair and lean back against the backrest.

**Caution** When the customer leans back against the backrest, support the customer's head with your hand. Failure to take this precaution may result in the customer's head hitting the basin.

- 4 Shampoo the hair.

**Caution**

- There is no function to secure the basin.
- Therefore, when the customer applies a load with the head exceeding a specific level, the basin may move. Encourage the customer to pay attention.
- The hairdresser must not lean on the basin. The basin may move, which is dangerous.

- 5 Raise the customer's body while supporting the customer's head with the hand.

- 6 Remove the shampoo cloth and allow the customer to exit the chair.

**Caution** <Product Integrated with Step>  
When the customer is getting out of the chair, if the leg is placed between the step and the chair, the customer may fall over. Be sure to inform the customer to be careful about the step.

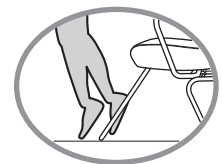

## 7 After using the product, wipe off any moisture.

- Moisture from the shower hose that dripped onto the floor.
- Moisture adhered to the main unit cover and outside the basin.
- Moisture collected in the water catcher.

### Caution

- After use, be sure to wipe off any moisture from all parts other than the basin. Leaving the product with water drops may result in failure or any contamination will not be removed.
- When the floor is wet, be sure to wipe the moisture off. Wet floors increase the possibility of slipping and falling or water leaks to the downstairs, thus resulting in accidents.

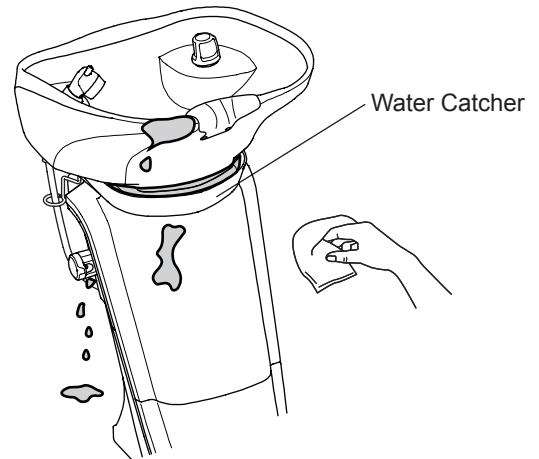

### Caution

The drain cap must be detached from the drain outlet when the product is not in use. If the lid is not detached, the lid may accidentally close, and the water may overflow the basin from the failure to notice water discharge, thus resulting in water leaks.

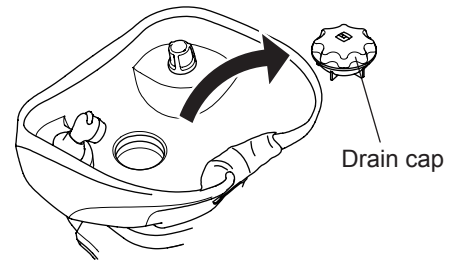

## ■ Adjusting the Basin Movement (PRIME, ELITE, RS Adria II)

Rotate the basin adjustment screw provided on the main unit with the supplied hexagonal-head wrench and set to an adequate position. The screw is provided on the right and the left sides.

<When basin movement is heavy>

Rotate the screw in the counterclockwise direction.

<When basin movement is light>

Rotate the screw in the clockwise direction.

The adjustment should be done on the opposite side.

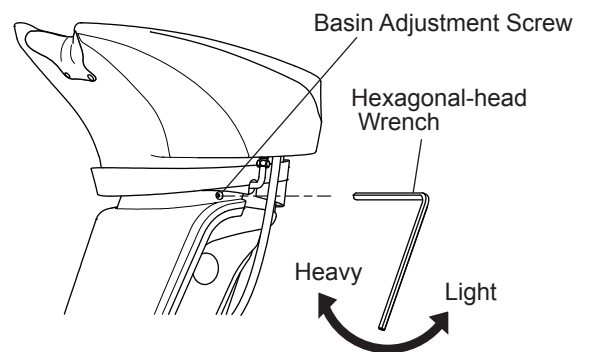

### Caution

- The basin adjustment screw will fall off if loosened too much. Pay attention to avoid losing the screw too much.
- The basin adjustment screw is provided on both the right and the left sides. Rotate the screw the same amount on both sides to adjust movement. Adjusting only one side may result in breakage of the basin.
- Do not drop the hexagonal-head wrench on the main unit. Failure to take this precaution may result in breakage of the main unit.
- Be sure to check basin movement after finishing the adjustment.

## ■Using the Spa-Showerhead

Changing the selection switch position switches between shower water discharge and air bubble water discharge.

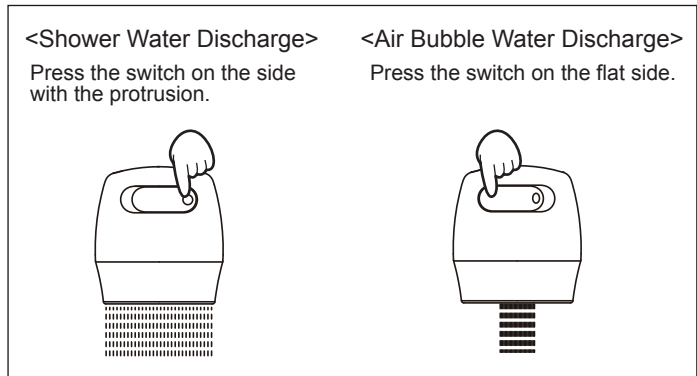
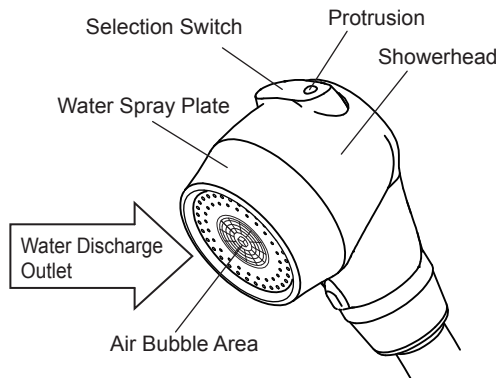

### ! Caution

- Do not discharge a strong water stream when the showerhead is in the showerhead receptacle. Failure to take this precaution may result in system failure due to spilled water or damage to the floor.
- After using the showerhead, be sure to put it back in the showerhead receptacle. Place it back into the receptacle so that the protrusion on the showerhead matches the recessed portion on the receptacle.

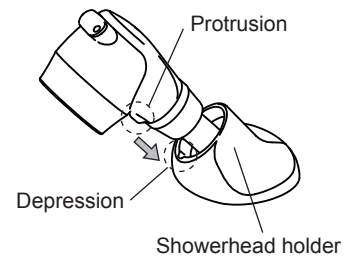

## ■Adjusting the volume of water (excluding AY-P073X,AY-074X)

A left (counterclockwise) rotation of the water stop knob increases the amount of hot water.

A full left (counterclockwise) rotation of the knob will output the maximum amount.

A full right (clockwise) rotation of the knob will stop the water.

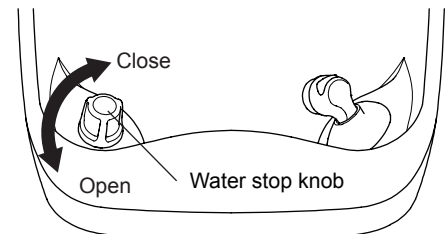

### Note

- A gushing sound may be emitted from the main body depending on the environment or conditions that it is used in. This sound is due to water flowing fast through pipes as a result of high water pressure or water volume control, and is not indicative of a defective product. This gushing sound can be reduced by adjusting the water pressure.
- The water stop knob may become stiffer when turned depending on the environment or condition that it is used in. This is due to deterioration of packing of movable parts or a lack of grease as a result of aging. Replacement of the packing or other parts, or a recoating of grease is required.

### ! Caution

- When the basin is not being used, turn the water stop knob firmly full right (clockwise) to turn the water off properly. Failure to do this may cause water leakage.
- After shampooing, do not cover the drain with the drain cap, towel or shampoo cloth as hot water may come out. Hot water that is accidentally trickle due to an increase in water pressure at night. This may cause water to spill from the basin, leading to water leakage.
- If the drainage become sluggish, the drainpipe may be clogged with dirt. Discontinue use and contact with your closest dealer.

## ■ Adjusting the water temperature (excluding AY-P073X,AY-074X)

- 1 Turn the temperature control knob in the H or C direction to set the temperature to an appropriate level.

### Caution

When adjusting the water temperature, reduce the volume of water, point the shower head away from the customer and check the temperature by hand. Take care when doing so, as hot water may come out of the shower head.

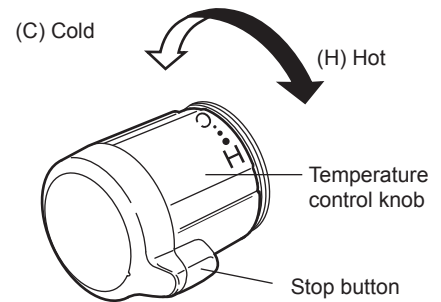

- 2 To use hot water turn the temperature control knob in the H direction while holding down the stop button.

### Caution

- Return the knob to an appropriate position after use. Continuing to use the hot water with the knob in the hot position may cause burns.
- Using other equipment that share the same water/hot water supply source at the same time may cause unstable water temperature. Do not execute any quick operation of the respective devices.
- Operate the temperature control knob only after removing metallic objects, such as rings and wristwatches. Failure to take this precaution may result in contact between the metal and the temperature control knob resulting in flaws or cracks on the plated surface and thereby causing peeling of the plating.
- Before using the product, check that there are no flaws, cracks, or peeling of the plated surface of the temperature control knob. If the plating is peeled off, immediately stop using the product and contact your closest dealer. Continued operation may result in personal injury.

\* For safety reasons, this product is designed so that hot water of approximately 53°C or higher is not output.  
(Conditions: At the same supply pressure, normal water temperature is 20°C and hot water temperature is 60°C)

### Note

- The water discharge amount may change significantly when controlling the hot water temperature depending on the operating environment or conditions. This phenomena occurs when the hot water temperature exceeds the recommended values (60°C to 80°C), there is significant difference in the water supply or hot-water supply pressure, or multiple devices are used at the same time-it is not equipment failure.
- The temperature of discharged water and the preset temperature may differ depending on the operating environment or conditions.  
(The system is designed so that the temperature of the discharged water will be about 40°C when the temperature control knob is rotated toward the H position and locked in that position.)  
This phenomena occurs when the hot water temperature exceeds the recommended values (60°C to 80°C), there is significant difference in the water supply or hot-water supply pressure, or multiple devices are used at the same time it is not equipment failure. The temperature of discharged water may be set at about 40°C when the temperature of hot water or the pressure of the water/hot water supply is adjusted and the locking position of the temperature control knob is adjusted. When you want to order an adjustment from us, contact your closest dealer.

## ■Accumulating Hot Water

To accumulate hot water for emulsification of hair color, rotate the drain cap in the clockwise direction to close the drain outlet. The amount of water should be below the level shown by the dotted line in the illustration on the right (just below the shower hose slot).  
When water accumulates and exceeds the dotted line, water may overflow from the shower hose slot.

To drain the accumulated water, rotate the drain cap in the counterclockwise direction to open the drain outlet.

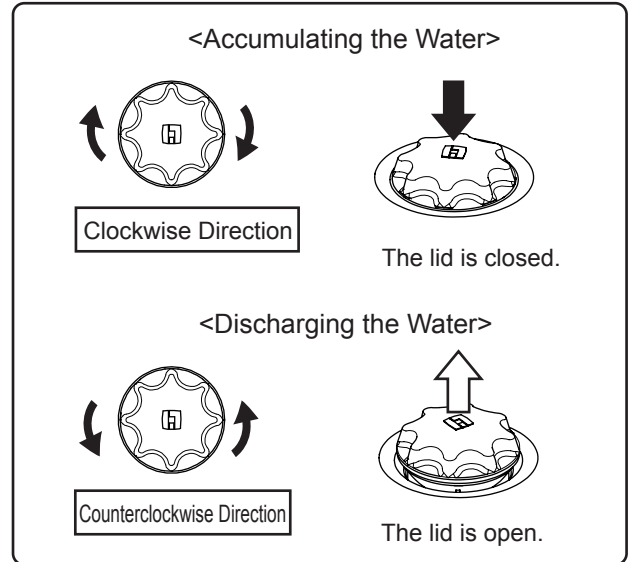
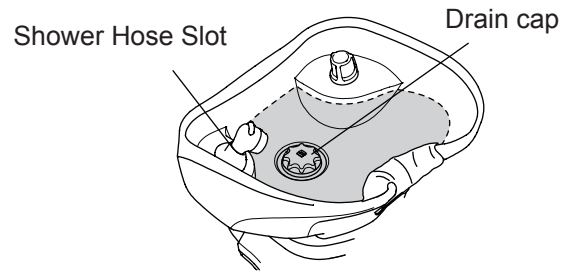

### ⚠ Caution

The drain cap must be detached from the drain outlet when the product is not in use. If the lid is not detached, the lid may accidentally close, and the water may overflow the basin from the failure to notice water discharge, thus resulting in water leaks.

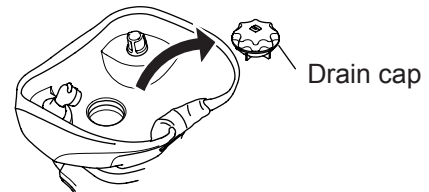

### ⚠ Caution

- Do not leave the showerhead in the water. Water may flow back when the water pressure in the water pipe decreases during a water outage.
- When the drainage speed slows, there is a possibility that dust and dirt may have clogged the drainpipe. Immediately stop using the product and contact your closest dealer.

<Lite or product with the lock tilt function>

Do not move the basin with water in it. Failure to take this precaution may result in overflow of water from the basin or splashing of water over your closest dealer.

### Note

The amount of accumulated hot water may decrease slightly in an amount that does not affect use. A small amount of water may flow out, which does not affect use. If the decreasing level is significant, the gasket of the drain cap may have deteriorated or become worn. Replace the drain cap. (Available at additional cost.)

# Maintenance

## ⚠ Caution

Never use volatile chemicals such as thinners, alcohol, gasoline or kerosene, cleaning products such as abrasive wax, a sponge with a scourer, detergents that include organic solvents, acidic, alkaline or chlorine-based detergents, or scouring pads. Failure to follow this instruction may cause scratches or discoloration.

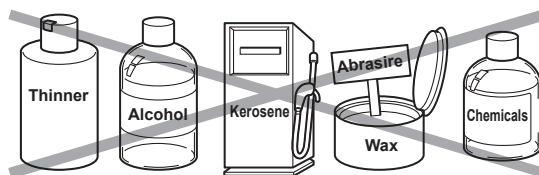

## ⚠ Caution

Be sure to execute daily maintenance according to the maintenance procedures stated in this section. In the case of insufficient or improper maintenance or when periodically replaced parts are not replaced, the customer shall be responsible for any harm, damage, or defects that result, and our company shall not assume responsibility.

## ■ Hair catcher

Pull out the hair catcher located under the drain cap and remove any hair that has been caught. The hair catcher is a consumable supply. Replace the hair catcher if it is extremely dirty or the surface has deteriorated. (available at additional cost)

## ⚠ Caution

Clean the hair catcher as regularly as possible. Continuing to use the hair catcher without cleaning can cause the drain to become blocked with hair, leading to water overflowing and unhygienic conditions. Try to clean the hair catcher after each shampoo.

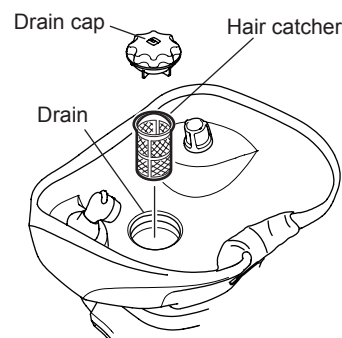

## ■ Trickle stopper rubber

At the end of work each day, wash with water to remove any hair or chemicals. Trickle stopper rubber is a consumable supply. Replace the trickle stopper rubber if it does not fit the shower hose firmly, or if it has become slippery or the surface has deteriorated. (available at additional cost)

## ⚠ Caution

The trickle guard rubber will not stop the water leaks completely. The water that overrides the rubber may fall on the main unit or on the floor. If this is the case, immediately wipe the water off. When the water is allowed to remain, there is a possibility of damage to the main unit or people slipping and falling due to water on the floor. In some cases, water may result in damage from water leaks.

### <Replacement method>

- 1 Remove the shower head.
- 2 Remove the old trickle stopper rubber.
- 3 Spread open the new trickle stopper rubber with both hands and fit it on to the hose.
  - The most effective attachment position is approximately 10 cm from the base of the shower head.
- 4 Attach the shower head.
  - Replacement is easier if performed by two people. The rubber may expand slightly during replacement, however it will contract and secure itself after some time.

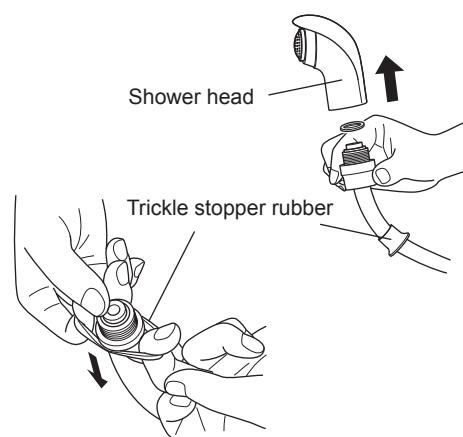



## ■ Basin

Wipe any dirt clean using detergent diluted with water.  
If streaked scratches appear due to contact with metallic objects such as watch bands, rub the area with a nylon scourer.

**Caution** Do not use a metallic scourer or sandpaper, as this will damage the basin.

**!** The fixing pins are designed to be detachable. Be careful not to lose them.

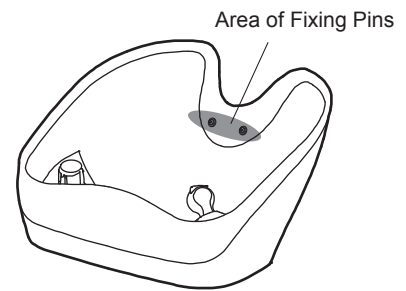

The area around the fixing pins of the neck cushion should be carefully cleaned with a cotton-tipped swab.

## ■ Neck cushion

At the end of work each day, wash the neck cushion with water, wipe them dry with a towel, and allow them to dry in the shade.

If they are extremely dirty, wash with detergent diluted with water, and rinse carefully with water.

The neck cushion is a consumable supply. Replace it if it is extremely dirty or the surface has deteriorated. (available at additional cost)

**Caution**

- If solvents drip onto the neck cushion, rinse with water as soon as possible. Failure to follow this instruction may cause deformation or discoloration.
- Clean the neck cushion every day. Leaving dirt uncleaned may cause them to get moldy.

## ■ Drain cap

Wash around the drain cap, and remove any hair or dirt from solvents.

The drain cap is a consumable supply.

If it is extremely dirty, remove the packing from the drain cap, wash with detergent solution diluted using water, and rinse carefully with water.

Replace the packing if degradation causes water to leak quickly when the basin is filled with water. (available at additional cost)

**Caution** The drain cap must be detached from the drain outlet when the product is not in use. If the lid is not detached, the lid may accidentally close, and the water may overflow the basin from the failure to notice water discharge, thus resulting in water leaks.

**!** The drain cap should be handled carefully. It may break if it is dropped.

**!** The drain cap gasket is fixed on the drain cap. If you try to remove it forcibly, the gasket may be damaged and the water in the basin may decrease at a faster pace.

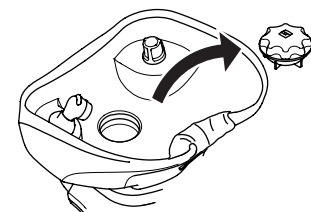
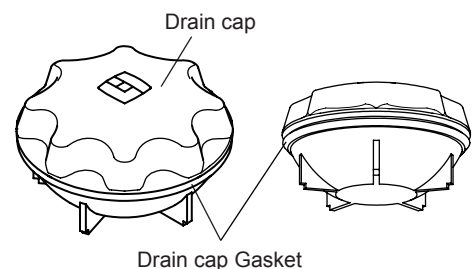

## ■ Water Catcher

The product is provided with a water catcher to prevent water leaks from the neck area trickling onto the cover or the floor when shampooing.

### Caution

The amount of water that can accumulate in the water catcher is limited. Be sure to wipe off the water or clean the catcher to prevent contamination after finishing shampooing.

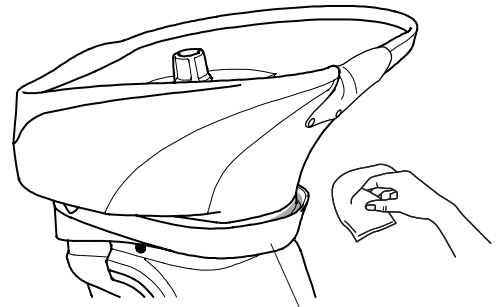

Water Catcher

## ■ Synthetic leather parts

Clean the leather every day after work. Leaving dirt uncleaned may cause mold to grow.

- Wipe with a soft, dry cloth or a damp cloth. If the leather is extremely dirty, wipe with a 10% detergent solution diluted using water, followed by a damp cloth, then wipe dry.
- If leather is stained by clothes or belts, it should be wiped clean as quickly as possible with a 10% detergent solution diluted using water to avoid further staining by the plasticizing agent.
- Take care to remove all water after wiping with a damp cloth. Any water that remains may encourage hydrolysis. Do not use solvents or bleach.
- Do not use leather cleaner containing solvents or scourers. The surface may degrade, leading to changes in the texture and luster. If leather cleaners are to be used, first check that there is no discoloration by testing in an area that is not visible.

### Caution

- Do not use the following items. Volatile chemicals such as thinners, alcohol, benzene, nail polish remover, gasoline or kerosene, wax with a scourer, or a sponge with a scourer.
- Do not use brushes or scouring pads. Do not use brushes or scouring pads when cleaning the leather. Failure to follow this instruction may cause scratches, and dirt may not be able to be removed.

## ■ Cover

Wipe clean with a soft, dry cloth. If they are extremely dirty, wipe with detergent diluted with water, and always wipe them dry.

### Caution

Never use volatile chemicals such as thinners, alcohol, nail polish remover, gasoline or kerosene, cleaning products such as wax with a scourer, a sponge with a scourer, detergents that include organic solvents, acidic, alkaline or chlorine-based detergents, or scouring pads. Failure to follow this instruction may cause scratches or discoloration.

## ■ Cleaning the Showerhead (Air Bubble Area)

<Air Bubble Showerhead>

- 1 The air bubble area of the showerhead should be cleaned once a month (as a general guide). Apply the supplied wrench to the chamfered portion of the air bubble fixture.

### Caution

Be careful not to pinch your hand or finger in the wrench.

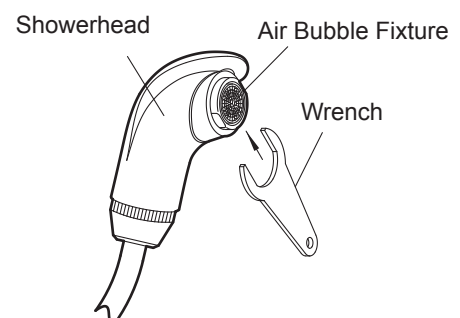

2 Rotate and loosen the air bubble fixture with the wrench.

3 Remove the three parts (rubber gasket, air bubble unit, and air bubble fixture) and wash with water using a nylon or similar brush.

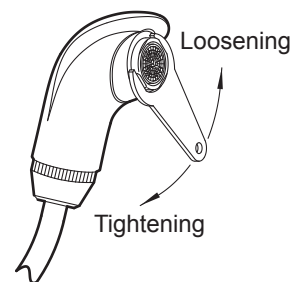
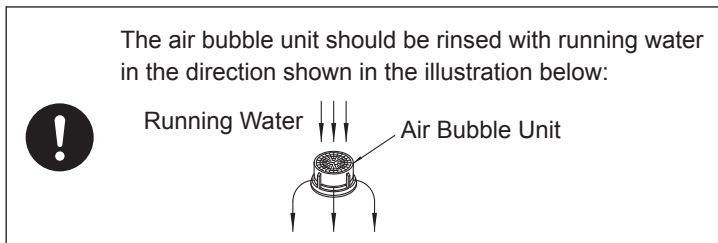

4 After cleaning, set the three parts in the order shown in the illustration.

5 Tighten the air bubble fixture with the wrench. This completes the cleaning.

The air bubble unit and the gasket can be reused after washing with water. If replacements are required due to deterioration or breakage, however, contact your closest dealer.

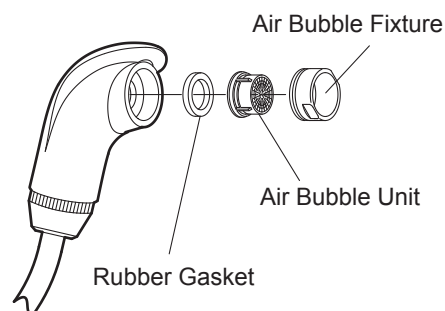

### <Spa Showerhead>

1 Rotate and detach the sprinkling filter unit and remove the three parts (sprinkling filter unit, air bubble unit, and rubber gasket).  
(\*Do not detach the O-ring.)

2 Clean the sprinkling filter unit (with water).  
Remove dirt, such as water deposits in the shower holes on the sprinkling filter unit, with a toothbrush.

3 Clean the air bubble unit (with water).  
Clean the unit once a month (as a general guide).  
Remove dirt, such as water deposits on the air bubble unit, with a toothbrush.

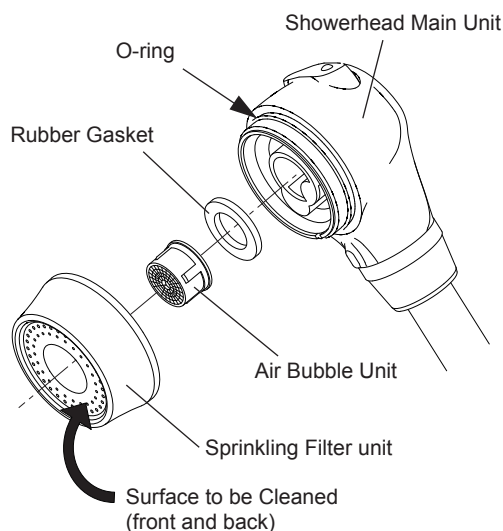
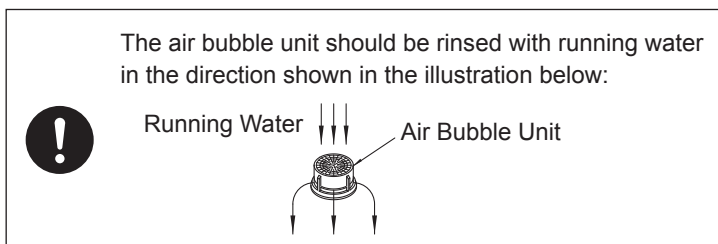

4 Re-assemble the showerhead.

#### <Assembling Procedures>

- (1) Insert the air bubble unit and the rubber gasket in the sprinkling filter unit in this order.
- (2) Mount the sprinkling filter unit on the showerhead main unit, while the water discharge side of the sprinkling filter unit facing down.

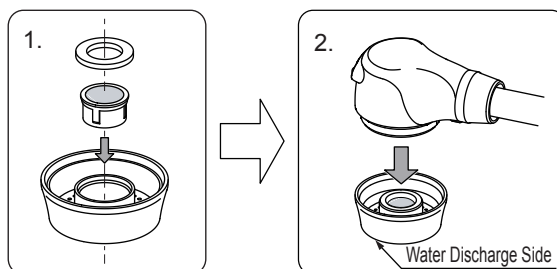

## ■Maintenance of the inside of the main unit <water draining and cleaning procedures>

excluding AY-P073X,AY-P074X

To use the basin for a long period of time, clean the strainer (inside the check valve) regularly. If temperatures are expected to drop below freezing in cold regions, drain the water from the check valve.



### Caution

In cold regions, always drain the water as a measure to prevent freezing. Failure to follow this instruction may cause water leakage.

Before and after using the product, check that water does not trickle out beneath the main unit. Check that water does not leak from the water supply pipe, hot-water supply pipe, and the joints of the drainage pipe. Be sure to inspect for water leaks and clean on a regular basis. (We recommend checking for water leaks at least once a month by opening the maintenance cover.)

- 1 Prepare a container for the water.
- 2 Detach the maintenance cover.  
The cover can be detached by pulling horizontally, while gently pressing the cover sides.



### Warning

The hot water supply pipe may become very hot. Take care not to touch the pipe directly.



After removing the maintenance cover, check that there is no water leakage within the basin. If there is water leakage, the pipes within the basin may be damaged.

If this is the case, contact your closest dealer. Leaving water leaks may sometimes result in serious accidents or water damage. In this case, the customer will be responsible for the accident and a significant amount of labor and costs will be incurred.

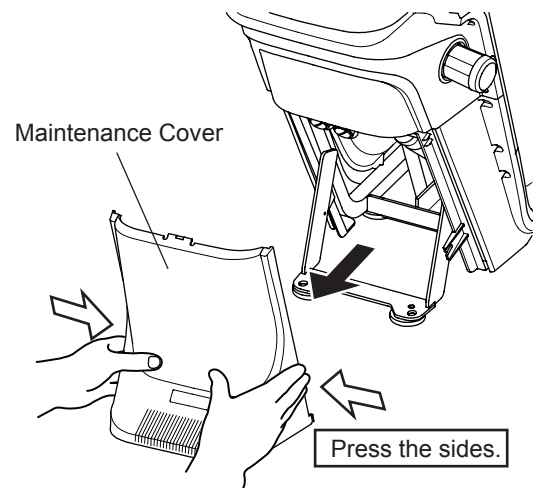

- 3 Drain the water from the stink trap and clean the trap. To drain the water into the container, rotate and detach the drain nut of the stink trap. After draining the water and cleaning the trap by removing dust and dirt, tighten the drain nut firmly.



### Caution

The water in the stink trap serves to prevent odors from sewage water. Be sure to add some water to the trap after cleaning.

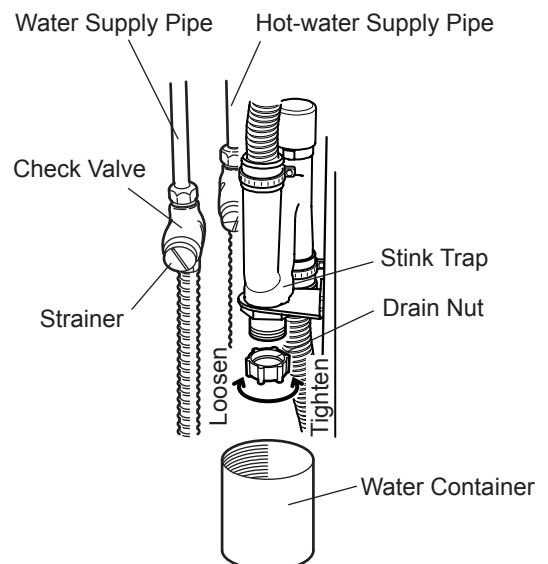

4 Close the hot water and water stop valves.



**Caution**

To prevent water leakage, always check that the stop valves are completely closed before cleaning or draining the water from the strainer.

5 Clean the strainer.

When the strainer is detached, the water in the pipe will come out. Therefore, rotate and detach the strainers of the check valves for hot water and water, while catching the water in a container. After completely draining the water from the check valve, clean the strainer by removing dust and dirt, set it in the original position, and tighten firmly.  
(Tool required: a blade-head screwdriver)

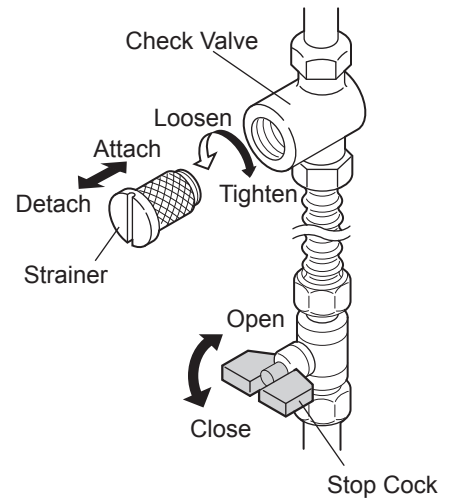

**Caution**

- Removing the strainer from the hot water supply pipe may cause hot water to spill out. Take extra care when draining the hot water.
- The drain nut and strainer should be tightened firmly. If they are not, there is a possibility of water leaks.
- If the drain water spills onto the floor, immediately wipe it up.

6 After checking that the strainers have been fastened properly, open the stop valves.  
Check that there are no water leaks from the check valve.

7 Mount the maintenance cover onto the main unit.  
The maintenance cover can be mounted by hooking the three latches on the main unit. First, hook the top latch and then hook the bottom two latches.

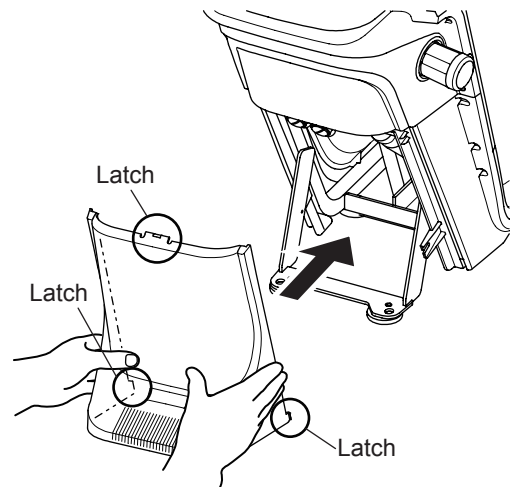

**Caution**

Check that the maintenance cover is properly secured with the three latches. If not, water may penetrate the main unit resulting in system failure.

**Note**

The "Parts Replaced on a Regular Basis" described on page 26 must be replaced on a regular basis to ensure and maintain safety and performance. Any part that is outside the designated replacement period must be replaced even if there is no problem during use. Our company will not assume responsibility for any harm, damage, or defects attributed to the fact that a part was not replaced within the designated period.

## Daily Inspections

- To ensure that this product can be used for a long period of time, follow the procedures outlined in "Procedures for Daily Inspections" on page 35 to 36 of this instruction manual.



Always inspect this product following the procedures outlined in "Procedures for Daily Inspections". Continuing to use this product without performing the daily inspections may cause malfunctions or accidents.

## Parts Replaced on a Regular Basis

The following are parts that must be replaced on a regular basis as designated by our company:

□ Drain hose: Replace every three years

-For the drain hose, there is a possibility that water leaks will occur because cracks are caused due to deterioration and hardening of the hose from chemical agents in the drain water.

-Damage to the hose may result in water flooding on or beneath the floor.

□ Check valve: Replace every three years

-When the check valve is used continuously for long periods of time, there is a possibility that the parts in the valve will deteriorate resulting in no water discharging, or sometimes, the sewage water once discharged from the water faucet will flow back, thus causing contamination of city water or public health problems.

□ Water/hot-water supply hose: Replace every three years

-For the water/hot-water supply hose, there is a possibility that cracks due to deterioration caused by equipment operation or residual chlorine or copper ions in the city water will cause water leaks.

-Damage to the hose may result in water flooding on or beneath the floor.

The above-listed parts must be replaced on a regular basis to ensure and maintain safety and performance. Any part that is outside the designated replacement period must be replaced even if there is no problem during use. (The parts are available at additional cost.) Our company will not assume responsibility for any harm, damage, or defects attributed to any part that was not replaced within the designated period. For ordering replacement work, contact your closest dealer.

## Standard Duration of Use

The standard period of use of this product is seven years.

The standard period of use is "a guide for the standard period that this product can be used properly from a safety perspective, when conducting appropriate maintenance and inspections (including replacement of parts) for the standard usage conditions for each product. This is not the same as the warranty period.

# Before Requesting Repairs

If the following problems arise, conduct the checks outlined before requesting repairs.

Symptom	Check this	Solution
• Water does not come out.	Is the water stop faucet of the pipe open?	Open the water stop faucet. (See pages 20 and 21.)
• The water temperature is low.	Is the temperature setup of the hot-water supply equipment proper?	Adjust the temperature setup of the hot-water supply equipment to the proper temperature.
	Is the temperature setup of the temperature control knob proper?	Adjust the temperature setup of the temperature control knob to the proper temperature. (See page 14.)
• The water drains poorly from the drain outlet.	Is hair clogging the hair catcher?	Remove the hair clogging the hair catcher. (See page 16.)
	Is the stink trap clogged?	Remove the dirt clogging the stink trap. (See page 20.)
• Sounds are generated when hot water is supplied.	Do the sounds vary when the hot water amount is adjusted with the stop water knob?	Feed the water by adjusting the hot water amount. (See page 13.)
• Sounds are generated from inside the product main unit when water is discharged.	Does the sound level decrease when the water stop knob is rotated to reduce the hot water amount?	Feed the water by adjusting the hot water amount. (See page 13.)

If the product does not operate properly after checking and repairing the above points, stop using the product immediately.

# Consumable Supplies

The following parts are "consumable supplies" and wear, degradation, changes in external appearance and damage are expected.

Please note that repair or replacement of these parts is not covered by warranty, and a fee will be required. (\* The level and period of wear, degradation or damage may differ depending on the environment and conditions that the customer uses this product in.)

Inspections or replacement of parts will be required if there is extensive wear, degradation or damage.

## Consumable Parts

(The following parts are not covered by the warranty; the cost of replacement is your responsibility.)

- Neck cushion     Drain cap     Shower hose     Hair catcher
- Showerhead

Furthermore, flaws, contamination, deterioration, and discoloration of the exterior parts below are not covered by the warranty.

- Covers, frames, and basin;
- Upholstered parts (backrest, seat, armrest and leg rest);
- Knobs (water stop knob, temperature control knob, etc.); and
- Other parts (floor step, armrest pad, lumbar section, etc.).

## **Disposing of This Product**

When disposing of this product or replaced parts, adhere with current regulations and dispose of them appropriately.

## **After-sales Service**

To request after-sales service, contact your closest dealer or Takara Belmont (UK) LTD directly.



# Specifications

Part Number AY-P069X / SU-191BW

Outside Dimensions	See the "Product Dimensions" on page 26		
Basin tilting angle	Basin free tilt type(PRIME,ELITE, RS Adria II): -12° / 8°		
Neck height	Basin free tilt type(PRIME,ELITE, RS Adria II): 864 / 951 mm		
Mixing type	Thermostat type		
Water discharging type discharging amount (hot-water pressure/water pressure: 0.1 MPa, respectively)	Spa Showerhead	Water discharge from shower : 9.0 L/min	
		Air bubble water discharge : 8.0 L/min	
	Air Bubble showerhead	Air bubble water discharge : 8.0 L/min	
Water stop faucet	Single faucet (rotary type)		
Operating environment	Operating temperature: 10/40 °C		
	Operating humidity: 95% or below (No condensing)		
*Hot-water supply temperature	80°C or below		
* Hot-water/water supply pressure	<ul style="list-style-type: none"> <li>- 0.1/0.4MPa(1 to 4 kgf/cm<sup>2</sup>)</li> <li>- Water supply pressure ≥ Hot-water supply pressure</li> <li>- Difference between hot-water supply pressure and water supply pressure: Within 0.2 MPa (2kgf/cm<sup>2</sup>)</li> </ul>		
Weight	Main unit	Basin free tilt type	42.0kg
	Chair	Chair(RS Adria II)	16.2kg
		Chair (PRIME)	17.0kg
		Chair (ELITE)	18.5kg

\*For details of the hot-water supply temperature, hot-water/water supply pressures, see the RS Adria II Installation Instructions.

# Product Dimensions

RS Adria II

[Unit: mm]

## ■ Top View

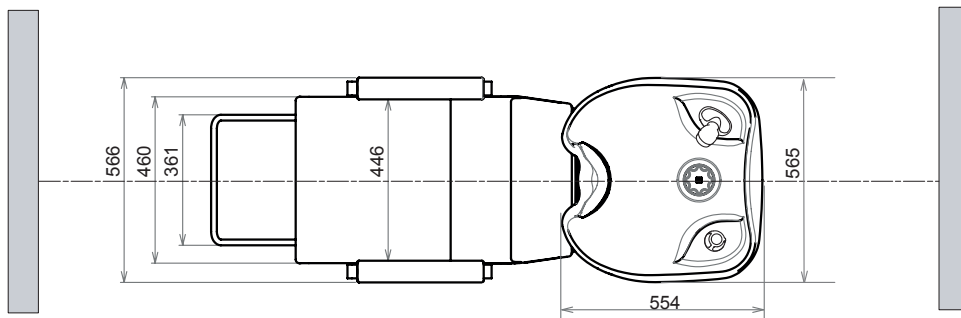

## ■ Side View

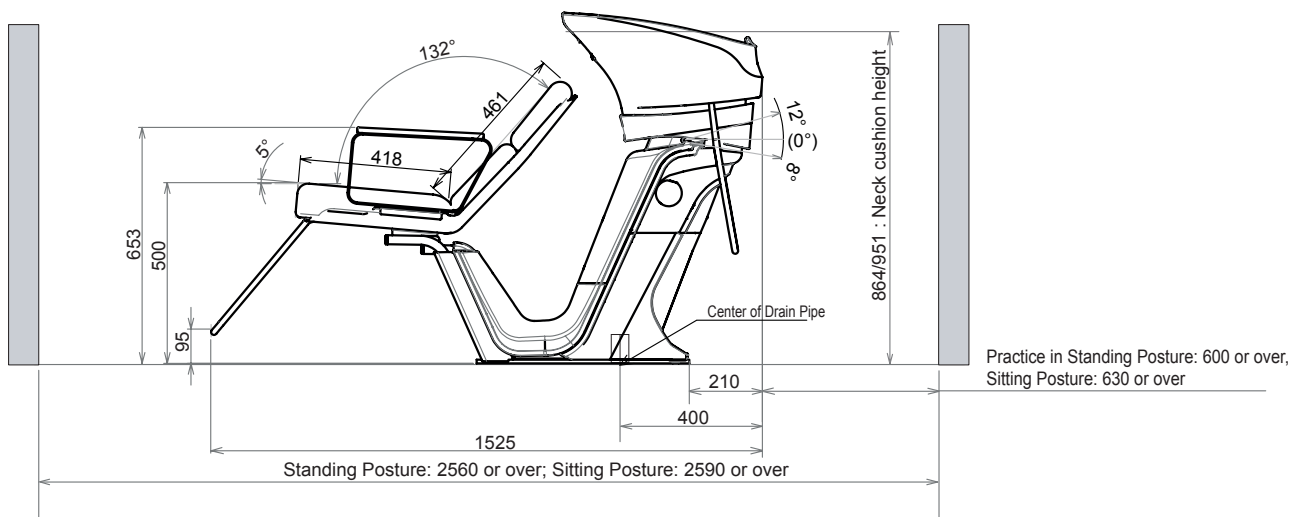

# Procedures for Daily Inspections

To ensure that this product can be used for a long period of time, conduct the inspections below.

## ■ Inspect the product every day

Inspection item	Inspection method	If the inspection results show defects
<input type="checkbox"/> Is the plating of the water stop knob and the temperature control knob peeled off?	<input type="checkbox"/> Visually check the water stop knob and the temperature control knob for flaws, cracks, or peeling of the plated surface.  <input type="checkbox"/> During operation or maintenance, check that there are no burrs or irregularities on the surface.	<input type="checkbox"/> Flaws, cracks, or peeling of the plated surface may result in injury of hand. If they exist, replacement of the knob is required. Contact your closest dealer.
<input type="checkbox"/> Has the neck cushion degraded?	<input type="checkbox"/> Check that there is no tearing, dirt or sinking of the neck cushion surface.	<input type="checkbox"/> These may cause pain or transfer dirt to the customer's neck and head. The neck cushion is consumable supplies. Replace it as soon as possible.
<input type="checkbox"/> Is the mounting surface of the basin unit wet with water?	<input type="checkbox"/> Open the maintenance cover and check that the mounting surface and pipes are not wet with water.	<input type="checkbox"/> There is a possibility that water is leaking from the pipes. If this is the case, immediately stop using the product and contact your closest dealer.
<input type="checkbox"/> Is there an abnormal odor coming from the basin drain?	<input type="checkbox"/> Check if there is an abnormal odor coming from the basin drain	<input type="checkbox"/> Remove any hair and other objects trapped in the hair catcher. (see page 18)
<input type="checkbox"/> Does the water stop knob work properly?	<input type="checkbox"/> Turn the water stop knob and check if warm water is output properly and that there is no abnormal noise, then close the water stop knob and check that warm water stops properly. <small>* An abnormal gushing sound may be emitted as water flows. (see page 13)</small>	<input type="checkbox"/> If there is abnormal noise or the water does not turn off properly when the water stop knob is closed firmly, there may be a malfunction in the stop valves of the water stop knob.
<input type="checkbox"/> Is water output from the shower head properly?	<input type="checkbox"/> Feed the hot water, and visually check that water is discharged normally from the showerhead, water is not leaking from the air bubble fixture, or the hot water is not turbid.	<input type="checkbox"/> If hot water is not fed normally, clean the strainer (see pages 20 and 21) and the inside of the showerhead. (See pages 18 and 19.)  <input type="checkbox"/> If water is leaking from the air bubble fixture or from the base of the showerhead, the internal gasket may be worn out. If replacement is required, contact your closest dealer.  <input type="checkbox"/> If the hot water is turbid, there is a possibility that the strainer of the check valve is contaminated. Clean the strainer. (See pages 20 and 21.)
<input type="checkbox"/> Does the basin, backrest or seat rattle?	<input type="checkbox"/> Slowly push the rear end of the basin, top of the backrest or the front end of the seat in each direction, and check whether they rattle.	<input type="checkbox"/> Rattling may cause incorrect operation or damage in the main body, or cause it to fall over. Stop using the product.

# Procedures for Daily Inspections (Continued)

To ensure that this product can be used for a long period of time, conduct the inspections below.

Inspection item	Inspection method	If the inspection results show defects
<input type="checkbox"/> Does the temperature control knob work properly?	<input type="checkbox"/> Turn the temperature control knob, check that the water temperature is adjusted properly and that there is no abnormal noise.* An abnormal gushing sound may be emitted as water flows. (see page 13)	<input type="checkbox"/> If the water temperature cannot be adjusted properly or if there is abnormal noise, there may be a problem with the thermostat within the basin. Stop using the product immediately.
<input type="checkbox"/> Can the basin be filled with water?	<input type="checkbox"/> Check that the drain cap can be used to block the drain and that water filling the basin does not drain.	<input type="checkbox"/> When the water decreases quickly, there is a possibility that the drain cap gasket has deteriorated. The drain cap gasket is a consumable part. Immediately replace it. (See page 17.)

## ■ Items that must be inspected after closing for the day

Inspection item	Inspection method	If the inspection results show defects
<input type="checkbox"/> Is the drain blocked?	<input type="checkbox"/> Check that the drain is not blocked with the drain cap, towel or shampoo cloth.	<input type="checkbox"/> Remove the object that is blocking the drain. If the drain is blocked, water that is turned on accidentally or a slight trickle of water due to an increase in water pressure at night may cause water to spill from the basin, leading to water leakage.
<input type="checkbox"/> Has the water stop knob been turned firmly?	<input type="checkbox"/> Turn the water stop knob firmly in a clockwise direction and check that	<input type="checkbox"/> Turn the water stop knob firmly and turn the water off properly. If the water does not turn off completely, there may be a malfunction in the stop valves of the water stop knob. Close the stop valves in the water supply pipe and hot water supply pipe (see page 20, 21), and stop using the product immediately.

## ■ Items that must be inspected once each week

Inspection item	Inspection method	If the inspection results show defects
<input type="checkbox"/> Is there any water leaking within the basin?	<input type="checkbox"/> Remove the basin maintenance cover and check that there is no water leaking from the internal pipes or water taps (see page 20, 21).	<input type="checkbox"/> If water is leaking from the pipes, the pipes or packing may be worn, degraded or damaged. Close the stop valves in the water supply pipe and hot water supply pipe (see page 20, 21), and stop using the product immediately.
<input type="checkbox"/> Is there any water scale or dirt blocking the spray nozzle?	<input type="checkbox"/> Remove the spray nozzle from the shower head and check that there is no water scale or dirt on it (see page 18, 19).	<input type="checkbox"/> Use an item such as a toothbrush to remove any dirt such as water scale and clean the spray nozzle. Leaving the spray nozzle uncleaned will lead to blockage, and water may not be output from the shower head properly.

**TAKARA  
BELMONT**

TAKARA BELMONT (UK) LTD

Belmont House, One St. Andrews Way, Bow, London E3 3PA, U.K.

TEL : +44(0)20 7515 0333 FAX : +44(0)20 7987 3596

Printed in UK